





Product Specification				
	Model: GKTV57NNAD1E0	Rev. No.	Issued Date.	Page.
		A	2010,Dec,09	1 / 19

Thin-Film-Transistor LCD Module
Model: GKTV57NNAD1E0

Acceptance

Solomon Goldentek Display Corp.
 NO. 18 Ta-Yeh St., Ta-Fa Industrial Park, Ta-Liao
 Hsiang, Kaohsiung Hsien 831, TAIWAN , R.O.C.
 FAX: 886-7-7886800

Approved and Checked by

Approved by	Checked by		Made by
			

Product Specification

	Model: GKTV57NNAD1E0	Rev. No.	Issued Date.	Page.
		A	2010,Dec,09	2 / 19

Revise Records

Rev.	Date	Contents	Written	Approved
A	2010/05/14	Preliminary Specification	Kobe Su	Sychang
A	2010/12/09	Add RoHS Compliance	Kavin Chang	Sychang

Special Notes

Note1.	
Note2.	
Note3.	
Note4.	
Note5.	

Product Specification				
	Model: GKTV57NNAD1E0	Rev. No.	Issued Date.	Page.
		A	2010,Dec,09	3 / 19

Contents

- 1. GENERAL DESCRIPTION AND FEATURES.....4**
 - 1.1 Features4
 - 1.2 LCD Module4
- 2. MECHANICAL INFORMATION.....4**
- 3. ELECTRICAL SPECIFICATIONS5**
 - 3.1 Absolute Max. Ratings5
 - 3.2 Electrical Characteristics7
 - 3.3 AC Timing Characteristic of The LCD8
 - 3.4 Back-Light Unit.....10
- 4. OPTICAL CHARACTERISTICS..... 11**
 - 4.1 Optical characteristic of the LCD 11
- 5 I/O TERMINAL14**
 - 5.1 Pin Assignment14
 - 5.2 Block Diagram16
 - 5.3 Back-light Unit (BLU)16
 - 5.4 Basic Display Color and Gray Scale.....17
- 6 TEST18**
- 7 DIMENSIONAL OUTLINES.....19**

Product Specification

	Model: GKT57NNAD1E0	Rev. No.	Issued Date.	Page.
		A	2010,Dec,09	4 / 19

1. GENERAL DESCRIPTION AND FEATURES

GKT57NNAD1E0 is a transmissive type color active matrix TFT (Thin Film Transistor) liquid crystal display (LCD) that uses amorphous silicon TFT as a switching device. This model is composed of a TFT-LCD module, a driver circuit and a back-light unit. Graphics and texts can be displayed on a VGA 640 (W) x 3 x 480 (H) dots with 262,144 colors by supplying 18 bits data signal (6bits/each color). The following table described the features of GKT57NNAD1E0.

1.1 Features

- Transmissive and back-light with 30th LEDs are available.
- TN (Twisted Nematic) mode.
- Digital RGB (6bits/color) data transfer.
- RoHS Compliance

1.2 LCD Module

Item	Specification	Unit
Screen Size	5.7 inches	Diagonal
Display Resolution	640 (H) x 480 (V)	Pixel
Active Area	115.20 (H) x 86.40 (V)	mm
Outline Dimension	144.00 (H) x 104.60 (V) x 13.0 (T)	mm
Display Mode	Normally white mode/ Transmissive/ Wide view	--
Pixel Arrangement	R,G,B Vertical Tripe	--
Pixel size	181.5 x 181.5	um
Display Color	262K Colors	--
Viewing Direction	12 o'clock (Gray Inversion)	--
Input Interface	Digital RGB (6bits/color) Data Transfer	--

2. MECHANICAL INFORMATION

Item	Min.	Typ.	Max.	Unit	Note
Module Size	Horizontal (H)	--	144.00	--	mm (1)
	Vertical (V)	--	104.60	--	mm (1)
	Thickness (T)	--	13.0	--	mm (1)
Weight	--	154	--	g	--

Note (1) Excluding backlight cables. . Refer to the Outline Dimension Drawing as attached.

(2) Back-light unit is included.

(3) Excluding backlight cables.

Product Specification

	Model: GKTV57NNAD1E0	Rev. No.	Issued Date.	Page.
		A	2010,Dec,09	5 / 19

3. ELECTRICAL SPECIFICATIONS

3.1 Absolute Max. Ratings

3.1.1 Absolute Ratings of Environment

If the operating condition exceeds the following absolute maximum ratings, the TFT LCD module may be damaged permanently.

(Ta=25±2°C, V_{SS}=GND=0)

Item	Symbol	Min.	Max.	Unit	Note
Storage temperature	T _{STG}	-30	80	°C	(1)
Operating temperature	T _{OPR}	-20	70	°C	(1,2,3)

Note (1) 95 % RH Max. (40 °C ≥ Ta). Maximum wet-bulb temperature at 39 °C or less. (Ta > 40 °C) No condensation.

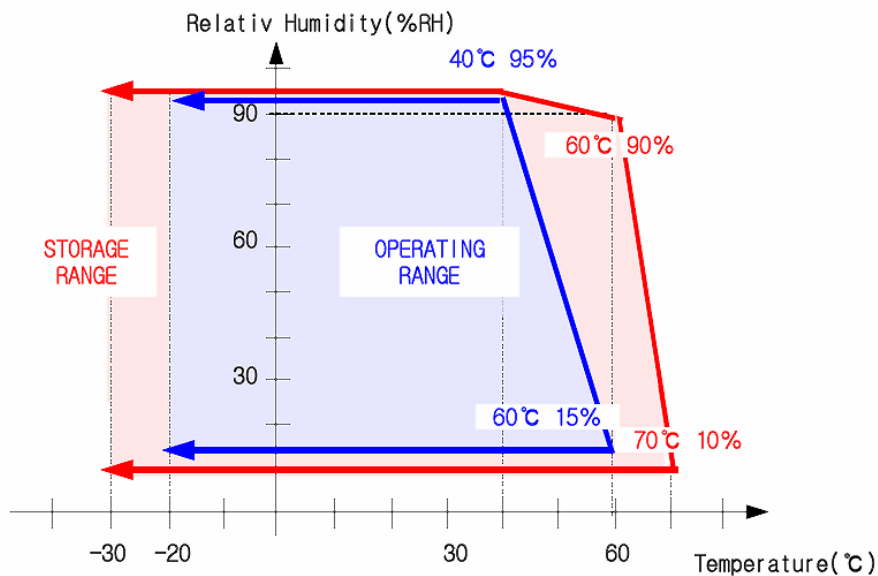

Note (2) In case of below 0°, the response time of liquid crystal (LC) becomes slower and the color of panel becomes darker than normal one. Level of retardation depends on temperature, because of LC's character

Note (3) Only operation is guaranteed at operating temperature. Contrast, response time, another display quality are evaluated at +25°C.

Product Specification

	Model: GKT57NNAD1E0	Rev. No.	Issued Date.	Page.
		A	2010,Dec,09	6 / 19

3.1.2 Electrical Absolute Maximum Ratings

($V_{SS}=GND=0$)

Parameter	Symbol	Min.	Max.	Unit	Remark
Power supply voltage	V_{CC}	-0.3	5.0	V	
Signal input voltage	R0-R5,G0-G5, B0-B5,DCLK,DE	-0.3	$V_{CC}+0.3$	V	--
Permissive input ripple voltage	V_{RF}	--	100	mVp-p	$V_{CC} = +3.3V$

Display On/Off Sequence :

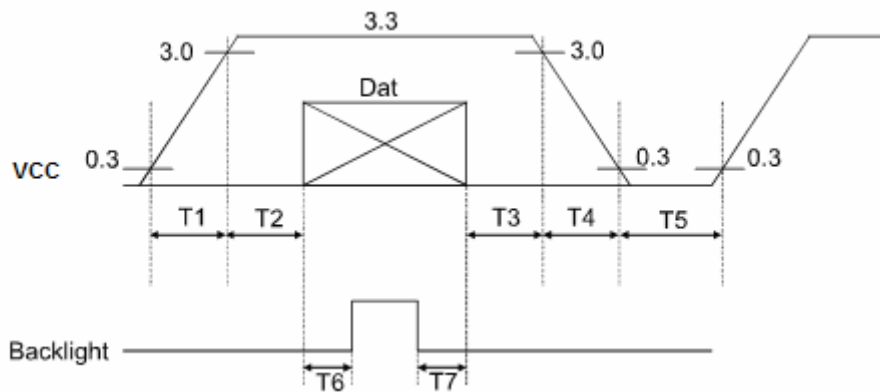

Data: DCLK, R0 ~ R5, G0 ~ G5, B0 ~ B5, DE

$T1 \leq 10ms$, $50ms \leq T2$, $0 < T3 \leq 50ms$, $0 < T4 \leq 10ms$, $1s \leq T5$, $200ms \leq T6$, $200ms \leq T7$

Product Specification

	Model: GKTV57NNAD1E0	Rev. No.	Issued Date.	Page.
		A	2010,Dec,09	7 / 19

3.2 Electrical Characteristics

3.2.1 DC Electrical Characteristics of the TFT LCD

(Ta=25±2°C, V_{SS}=GND=0)

Item	Symbol	Min.	Typ.	Max.	Unit	Remark
Power supply	VCC	3.0	3.3	3.6	V	Note 1
Input Voltage for logic	H Level	0.7VDD	-	VDD	V	
	L Level	0	-	0.3VDD	V	
Power Supply current	ICC		(120)	T.B.D	mA	Note 2

Note1: Vcc-dip conditions

Vcc-dip conditions should also follow the Vcc-turn-on conditions

Td ≤ 10ms

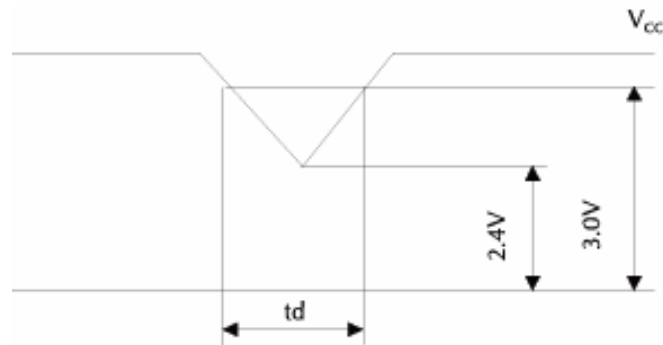

Note2: fv =60Hz , Ta=25°C , Display pattern : 64 Gray pattern

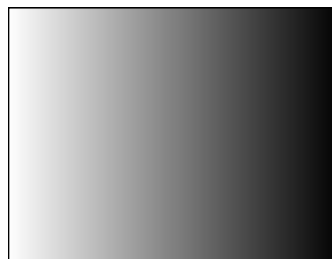

Product Specification

	Model: GKTV57NNAD1E0	Rev. No.	Issued Date.	Page.
		A	2010,Dec,09	8 / 19

3.3 AC Timing Characteristic of The LCD

3.3.1 Timing Condition

Parameter	Symbol	Min.	Typ.	Max.	Unit.	Remark
CLK frequency	F_{CPH}	--	25.175	--	MHZ	
CLK period	T_{CPH}	--	39.7	--	ns	
CLK pulse duty	T_{CWH}	40	50	60	%	
HS period	T_H	--	800	--	T_{CPH}	
HS pulse width	T_{WH}	5	30	--	T_{CPH}	
HS-DEN time	T_{HS}	112	144	175	T_{CPH}	
DEN pulse width	T_{EP}	--	640	--	T_{CPH}	
VS pulse width	T_{WV}	1	3	5	T_H	
VS-DEN time	T_{STV}	--	35	--	T_H	
VS period	T_V	--	525	--	T_H	

Note : When SYNC mode is used, 1st data start from 144th CLK after HS falling (when $STHD[5:0]=00000$)

Parameter	Symbol	Min.	Typ.	Max.	Unit.	Remark
OEV pulse width	T_{CVE}	--	100	--	T_{CPH}	
CKV pulse width	T_{CKV}	--	96	--	T_{CPH}	
HS-CKV time	T_1	--	52	--	T_{CPH}	
HS-OEV tim	T_2	--	8	--	T_{CPH}	
HS-POL time	T_3	--	72	--	T_{CPH}	
STV setup time	T_{SUV}	--	46	--	T_{CPH}	
STV pulse width	T_{WSTV}	--	1	--	T_H	

Product Specification



Model: GKTV57NNAD1E0

Rev. No.

Issued Date.

Page.

A

2010,Dec,09

9 / 19

3.3.2 Clock and Data input waveforms

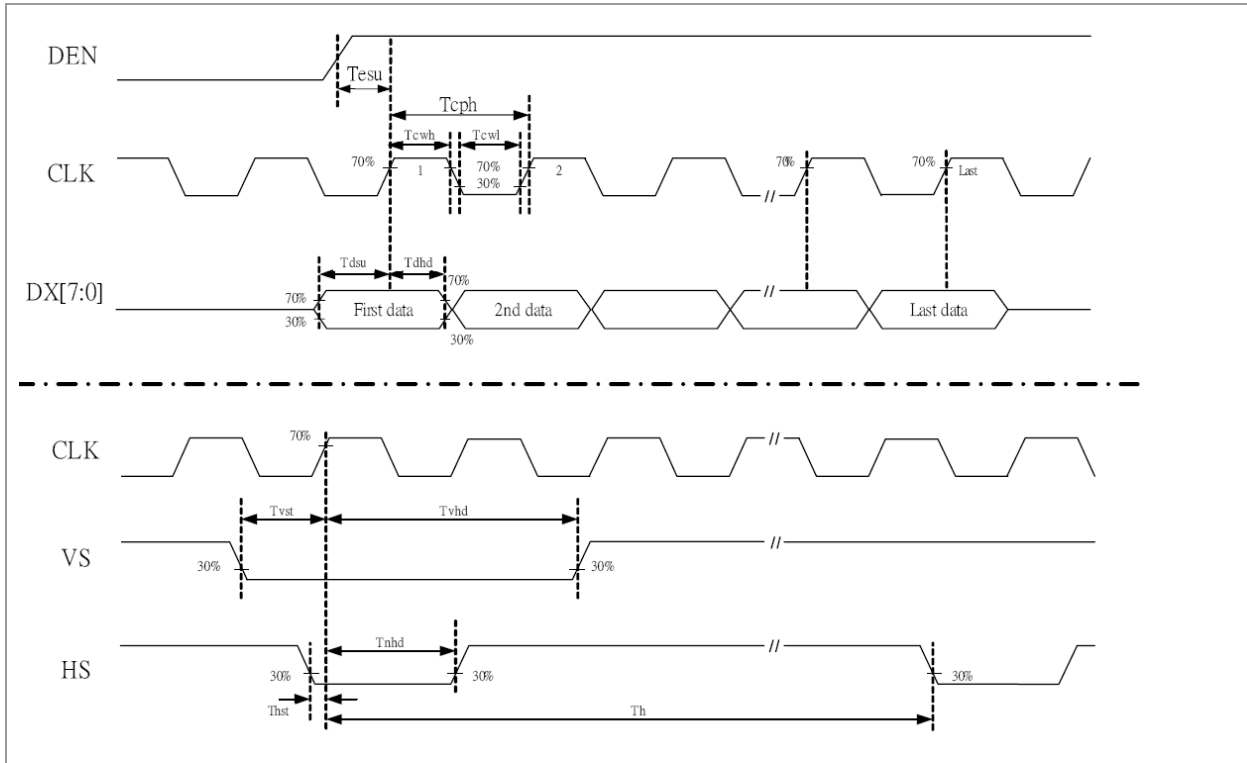

3.3.3 Data input format for parallel RGB Mode

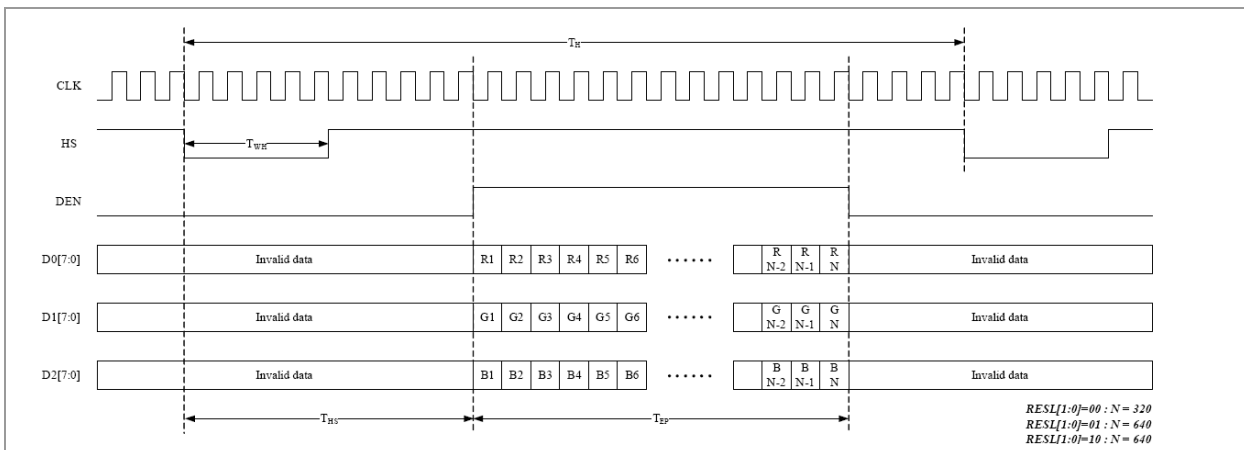

Product Specification

	Model: GKTV57NNAD1E0	Rev. No.	Issued Date.	Page.
		A	2010,Dec,09	10 / 19

3.3.4 Digital RGB mode Horizontal timing for RESL[1:0]=10

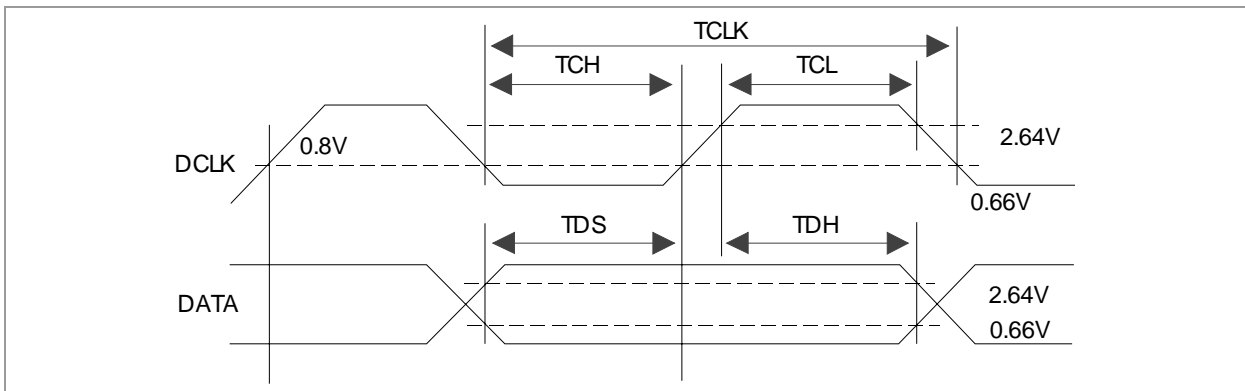
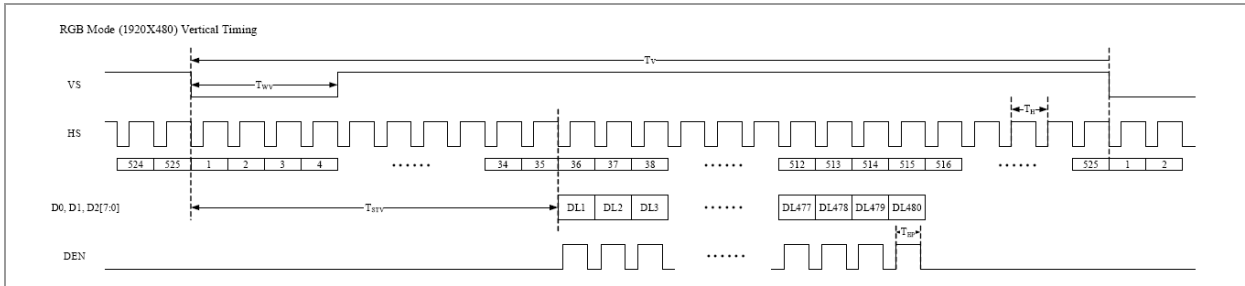

3.4 Back-Light Unit

The Back-light system is an edge-lighting type with 30 white LEDs(Light Emitting Diode). The characteristics of 30 white LEDs are shown in the following tables.

(Ta= Room Temp)

Characteristics	Symbol	Min.	Typ.	Max.	Unit	Note
Current	I_B	-	200	TBD	mA	(1)
Voltage Forward	V_F	-	(9.6)		V	
Power Consumption	P_{BL}	-	(1920)		mW	(2)
LED Life Time	25°C	-	(30000)	-	hr	(3)

Note (1) LEDS in 3 series x 10 parallel type.

(2) Where $I_B = 200\text{mA}$, $V_F = 9.6$, $P_{BL} = V_F \times I_B$

(3) The environmental conducted under ambient air flow ,at $T_a=25\pm 2^\circ\text{C}$,60%RH $\pm 5\%$

Product Specification

	Model: GKTV57NNAD1E0	Rev. No.	Issued Date.	Page.
		A	2010,Dec,09	11 / 19

4. OPTICAL CHARACTERISTICS

4.1 Optical characteristic of the LCD

The following items are measured under stable conditions. The optical characteristics should be measured in a dark room or equivalent state with the methods shown in Note (1).

Measuring equipment: BM-5A, BM-7

Item	Symbol	Condition	Min	Type	Max	Unit	Note
Brightness			(800)	(900)	--	cd/m ²	
Response time	T _r	θ=0°	-	15	20	ms	.
	T _f		--	25	35	ms	
Contrast ratio	CR	At optimized viewing angle	(300)	(450)	--	--	
Color Gamut	NTSC %	--	--	50	--	%	
Color Chromaticity (CIE 1931)	Red	R _x	θ=0° Normal Viewing Angle	(0.585)	(0.615)	(0.645)	--
		R _y		(0.314)	(0.344)	(0.374)	
	Green	G _x		(0.277)	(0.307)	(0.337)	--
		G _y		(0.532)	(0.562)	(0.592)	
	Blue	B _x		(0.103)	(0.133)	(0.163)	--
		B _y		(0.120)	(0.150)	(0.180)	
	White	W _x		(0.279)	(0.309)	(0.339)	--
		W _y		(0.320)	(0.350)	(0.380)	
Viewing Angle (12H)	Hor.	θ _R	CR≥10	55	65	--	Degree
		θ _L		55	65	--	
	Ver.	φ _H		55	65	--	
		φ _L		40	50	--	

Product Specification

	Model: GKTV57NNAD1E0	Rev. No.	Issued Date.	Page.
		A	2010,Dec,09	12 / 19

a. Test equipment setup

After stabilizing and leaving the panel alone shall be warmed up for the stable operation of LCM, the measurement should be executed. Measurement should be executed in a stable, windless, and dark room. Optical specifications are measured by Topcon BM-7(fast) with a viewing angle of 2° at a distance of 50cm and normal direction.

b. Definition of response time: Tr and Tf

The response time is defined as the following figure and shall be measured by switching the input signal for "black" and "white".

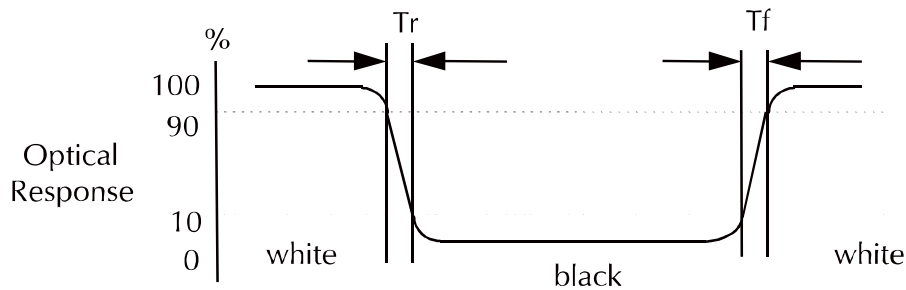

c. Definition of contrast ratio:

$$\text{Contrast Ratio (CR)} = \frac{\text{Brightness measured when LCD is at "white state"}}{\text{Brightness measured when LCD is at "black state"}}$$

d. Measured at the center area of the panel when all the input terminals of LCD panel are electrically opened.

Product Specification

	Model: GKTV57NNAD1E0	Rev. No.	Issued Date.	Page.
		A	2010,Dec,09	13 / 19

e. View Angle

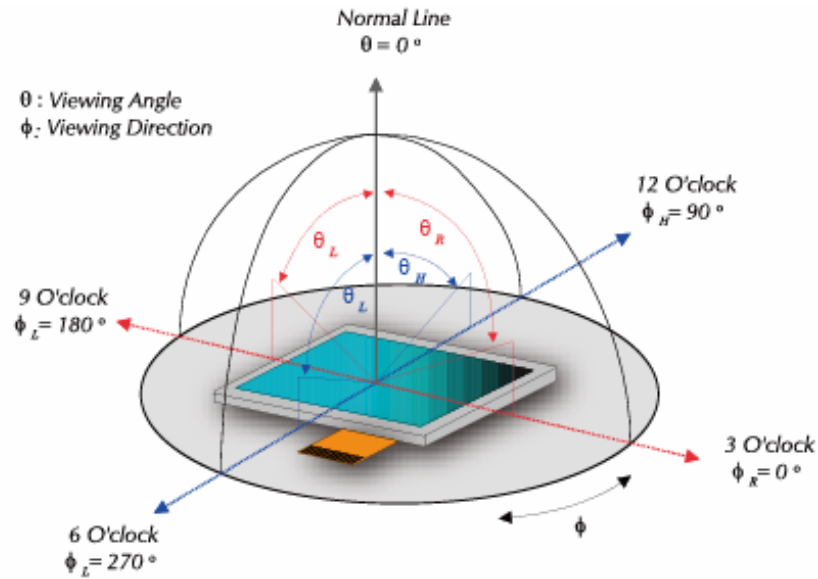

f. Definition of Luminance of White: Luminance of white at the center points

Light Source of Back-Light Unit	LED Type
---------------------------------	----------

g. Definition of White Uniformity

$$\text{White Uniformity} = \frac{\text{Min. luminance of white among 9-points}}{\text{Max. luminance of white among 9-points}} \times 100\%$$

h. The definition of Color Gamut -Color Chromaticity CIE 1931

Color coordinate of white & red, green, blue at center point.

Color Gamut : NTSC(%) = (RGB Triangle Area / NTSC Triangle Area) x 100

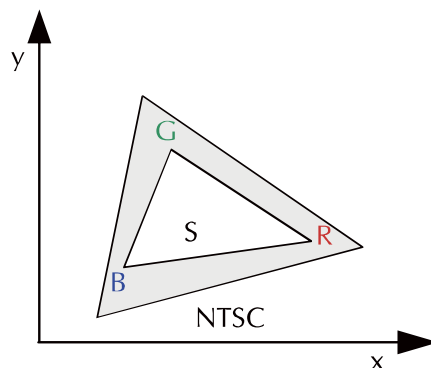

Product Specification

	Model: GKTV57NNAD1E0	Rev. No.	Issued Date.	Page.
		A	2010,Dec,09	14 / 19

5 I/O TERMINAL

5.1 Pin Assignment

Pin No.	Symbol	I/O	Function	Remark
1	DGND	--	GND	
2	DCLK	I	Clock signal for sampling each data signal	
3	Hsync	I	Horizontal synchronous signal (Negative)	
4	Vsync	I	Vertical synchronous signal (Negative)	
5	GND	I	GND	
6	R0	I	RED data signal (LSB)	
7	R1	I	RED data signal	
8	R2	I	RED data signal	
9	R3	I	RED data signal	
10	R4	I	RED data signal	
11	R5	I	RED data signal (MSB)	
12	GND	--	GND	
13	G0	I	GREEN data signal (LSB)	
14	G1	I	GREEN data signal	
15	G2	I	GREEN data signal	
16	G3	I	GREEN data signal	
17	G4	I	GREEN data signal	
18	G5	I	GREEN data signal (MSB)	
19	GND	--	GND	
20	B0	I	BLUE data signal(LSB)	
21	B1	I	BLUE data signal	
22	B2	I	BLUE data signal	
23	B3	I	BLUE data signal	
24	B4	I	BLUE data signal	
25	B5	I	BLUE data signal(MSB)	
26	GND	--	GND	
27	DEN	I	Signal to settle the horizontal display position (Positive)	Note5-1
28	VCC	--	3.3V power supply	
29	VCC	--	3.3V power supply	
30	LRC	I	Horizontal display mode select signal H: Normal L: Left / Right reverse mode	Note5-2
31	UDC	I	Vertical display mode select signal L: Normal H: Up / Down reverse mode	Note5-2
32	NC	--	No Connection	
33	GND	I	GND	

Product Specification

	Model: GKTV57NNAD1E0	Rev. No.	Issued Date.	Page.
		A	2010,Dec,09	15 / 19

Note5 - 1 The horizontal display start timing is settled in accordance with a rising timing of ENAB signal. In case ENAB is fixed "Low", the horizontal start timing is determined. Don't keep ENAB "High" during operation.

Note 5 - 2

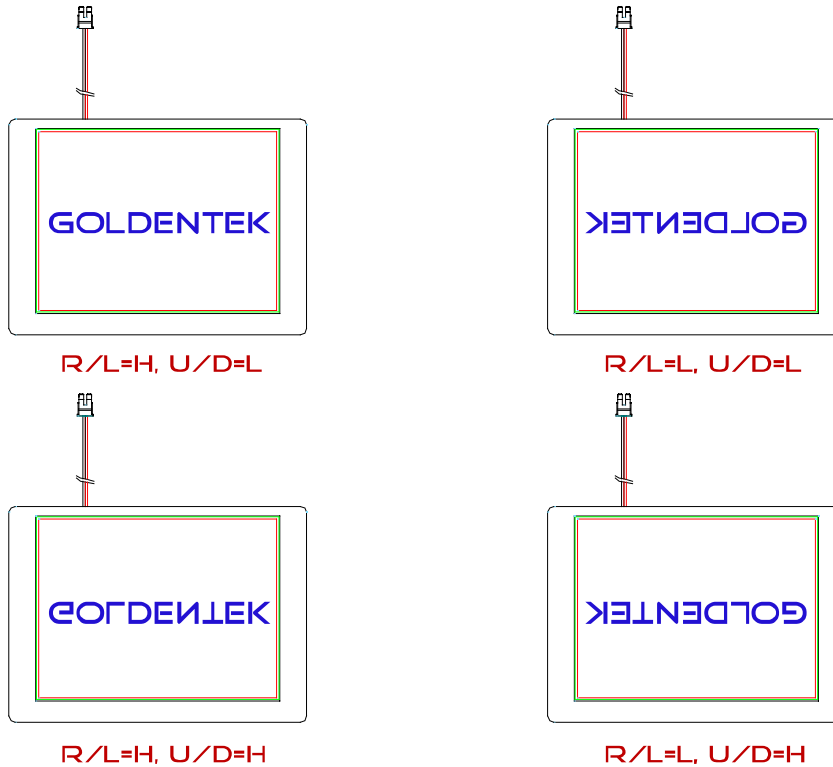

Product Specification

	Model: GKTV57NNAD1E0	Rev. No.	Issued Date.	Page.
		A	2010,Dec,09	16 / 19

5.2 Block Diagram

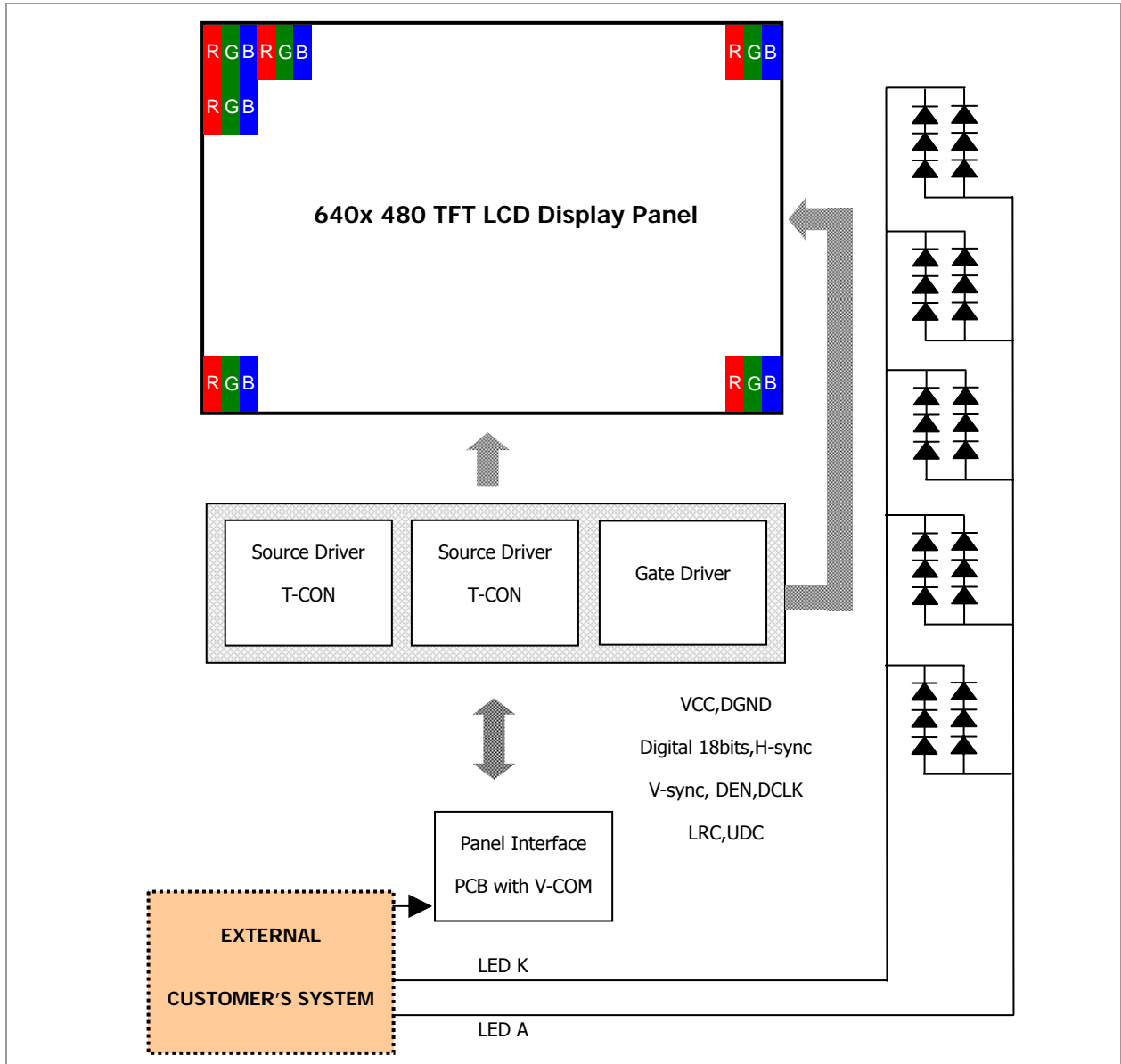

5.3 Back-light Unit (BLU)

Pin No.	Symbol	Function	Remark
1	LEDA	Power Supply for LED backlight	Red
2	LEDK	GND for LED backlight	Black

Connector: JST BHSR-02VS-1

Product Specification

	Model: GKTV57NNAD1E0	Rev. No.	Issued Date.	Page.
		A	2010,Dec,09	17 / 19

5.4 Basic Display Color and Gray Scale

	Color & Gray Scale	Data Signal																	
		R5	R4	R3	R2	R1	R0	G5	G4	G3	G2	G1	G0	B5	B4	B3	B2	B1	B0
Basic Color	Black	0	0	0	0	0	0	0	0	0	0	0	0	0	0	0	0	0	0
	Red(0)	1	1	1	1	1	1	0	0	0	0	0	0	0	0	0	0	0	0
	Green(0)	0	0	0	0	0	0	1	1	1	1	1	1	0	0	0	0	0	0
	Blue(0)	0	0	0	0	0	0	0	0	0	0	0	0	1	1	1	1	1	1
	Cyan	0	0	0	0	0	0	1	1	1	1	1	1	1	1	1	1	1	1
	Magenta	1	1	1	1	1	1	0	0	0	0	0	0	1	1	1	1	1	1
	Yellow	1	1	1	1	1	1	1	1	1	1	1	1	0	0	0	0	0	0
	White	1	1	1	1	1	1	1	1	1	1	1	1	1	1	1	1	1	1
Red	Black	0	0	0	0	0	0	0	0	0	0	0	0	0	0	0	0	0	0
	Red(1)	0	0	0	0	0	1	0	0	0	0	0	0	0	0	0	0	0	0
	Red(2)	0	0	0	0	1	0	0	0	0	0	0	0	0	0	0	0	0	0
	:	:	:	:	:	:	:	:	:	:	:	:	:	:	:	:	:	:	:
	Red(31)	1	1	1	1	1	1	0	0	0	0	0	0	0	0	0	0	0	0
	:	:	:	:	:	:	:	:	:	:	:	:	:	:	:	:	:	:	:
	Red(62)	1	1	1	1	1	0	0	0	0	0	0	0	0	0	0	0	0	0
	Red(63)	1	1	1	1	1	1	0	0	0	0	0	0	0	0	0	0	0	0
Green	Black	0	0	0	0	0	0	0	0	0	0	0	0	0	0	0	0	0	0
	Green(1)	0	0	0	0	0	0	0	0	0	0	1	0	0	0	0	0	0	0
	Green(2)	0	0	0	0	0	0	0	0	0	1	0	0	0	0	0	0	0	0
	:	:	:	:	:	:	:	:	:	:	:	:	:	:	:	:	:	:	:
	Green(31)	0	0	0	0	0	0	1	1	1	1	1	1	0	0	0	0	0	0
	:	:	:	:	:	:	:	:	:	:	:	:	:	:	:	:	:	:	:
	Green(62)	0	0	0	0	0	0	1	1	1	1	1	0	0	0	0	0	0	0
	Green(63)	0	0	0	0	0	0	1	1	1	1	1	1	0	0	0	0	0	0
Blue	Black	0	0	0	0	0	0	0	0	0	0	0	0	0	0	0	0	0	0
	Blue(1)	0	0	0	0	0	0	0	0	0	0	0	0	0	0	0	0	0	1
	Blue(2)	0	0	0	0	0	0	0	0	0	0	0	0	0	0	0	0	0	1
	:	:	:	:	:	:	:	:	:	:	:	:	:	:	:	:	:	:	:
	Blue(31)	0	0	0	0	0	0	0	0	0	0	0	0	1	1	1	1	1	1
	:	:	:	:	:	:	:	:	:	:	:	:	:	:	:	:	:	:	:
	Blue(62)	0	0	0	0	0	0	0	0	0	0	0	0	1	1	1	1	1	0
	Blue(63)	0	0	0	0	0	0	0	0	0	0	0	0	1	1	1	1	1	1

0 : Low level voltage, 1 :High level voltage

Each basic color can be displayed in 64 gray scales from 6 bit data signals. With the combination of total 18 bit data signals, the 262,144-color display can be achieved on the screen.

Product Specification

	Model: GKTV57NNAD1E0	Rev. No.	Issued Date.	Page.
		A	2010,Dec,09	18 / 19

6 TEST

No change on display and in operation under the following test condition.

Condition: Unless otherwise specified, tests will be conducted under the following condition.

Temperature: 20±5°C

Humidity: 65±5%RH

Tests will be not conducted under functioning state.

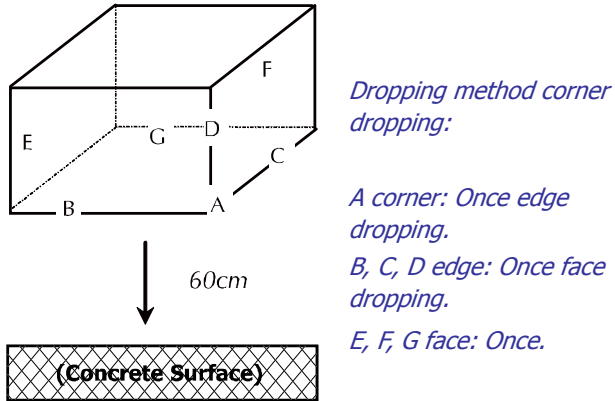
No.	Parameter	Condition	Notes
1	High Temperature Operating	70°C±2°C, 240hrs (Operation state).	-
2	Low Temperature Operating	-20°C±2°C, 240hrs (Operation state).	-
3	High Temperature Storage	80°C±2°C, 240hrs.	-
4	Low Temperature Storage	-30°C±2°C, 240hrs.	-
5	High Temperature and High Humidity Operation Test	60°C±2°C, 90%, 240hrs.	-
6	Vibration Test	Total fixed amplitude: 1.5mm. Vibration Frequency: 10~55Hz. One cycle 60 seconds to 3 direction of X, Y, Z each 15 minutes.	-
7.	Drop Test	To be measured after dropping from 60cm high on the concrete surface in packing state.  <p style="color: blue; margin-left: 20px;"><i>Dropping method corner dropping:</i></p> <p style="color: blue; margin-left: 20px;"><i>A corner: Once edge dropping.</i></p> <p style="color: blue; margin-left: 20px;"><i>B, C, D edge: Once face dropping.</i></p> <p style="color: blue; margin-left: 20px;"><i>E, F, G face: Once.</i></p>	-

Product Specification



Model: GKT V57NNAD1E0

Rev. No.

Issued Date.

Page.

A

2010, Dec, 09

19 / 19

7 DIMENSIONAL OUTLINES

